



Micro Commercial Components  
 21201 Itasca Street Chatsworth  
 CA 91311  
 Phone: (818) 701-4933  
 Fax: (818) 701-4939

# DLFR106 THRU DLFR107

## 1 Amp Glass Passivated, Fast Recovery Rectifier 800 to 1000 Volts

### Features

- Fast Switching Speed
- Low Leakage Current
- Metalurgically Bonded Construction
- Surface Mount Applications

### Maximum Ratings

- Operating & Storage Temperature: -65°C to +150°C
- Maximum Thermal Resistance; 30°C/W Junction To Lead

MCC Catalog Number	Device Marking	Maximum Reccurent Peak Reverse Voltage	Maximum RMS Voltage	Maximum DC Blocking Voltage
DLFR106	----	800V	560V	800V
DLFR107	----	1000V	700V	1000V

Electrical Characteristics @ 25°C Unless Otherwise Specified

Average Forward Current	$I_{F(AV)}$	1.0A	$T_J=55^\circ\text{C}$
Peak Forward Surge Current	$I_{FSM}$	30A	8.3ms half sine
Maximum Instantaneous Forward Voltage	$V_F$	1.3V	$I_{FM}=1.0A$ $T_A=25^\circ\text{C}$
Maximum DC Reverse Current At Rated DC Blocking Voltage	$I_R$	5.0uA 100uA	$T_J=25^\circ\text{C}$ $T_J=125^\circ\text{C}$
Maximum Reverse Recovery Times DLFR106 DLFR107	$t_{rr}$	250ns 500ns	$I_F=0.5A$ , $I_R=1.0A$ , $I_{rr}=0.25A$
Typical Junction Capacitance	$C_j$	15pF	Measured at 1.0MHz, $V_R=4.0V$

Pulse test: Pulse width 300 usec, duty cycle 1%.

### MELF

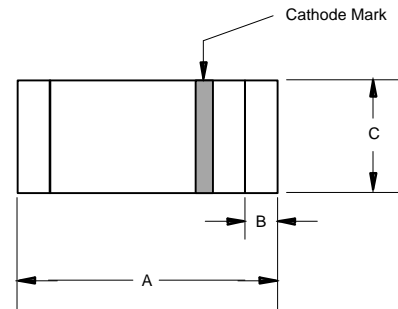

DIM	DIMENSIONS				NOTE
	INCHES		MM		
A	.190	.205	4.80	5.20	
B	---	.022	---	.55	Nominal
C	.095	.105	2.40	2.67	∅

### SUGGESTED SOLDER PAD LAYOUT

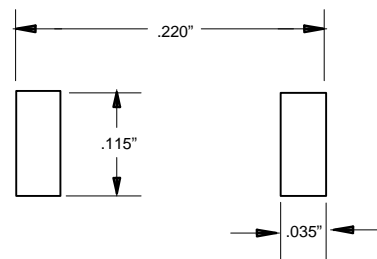
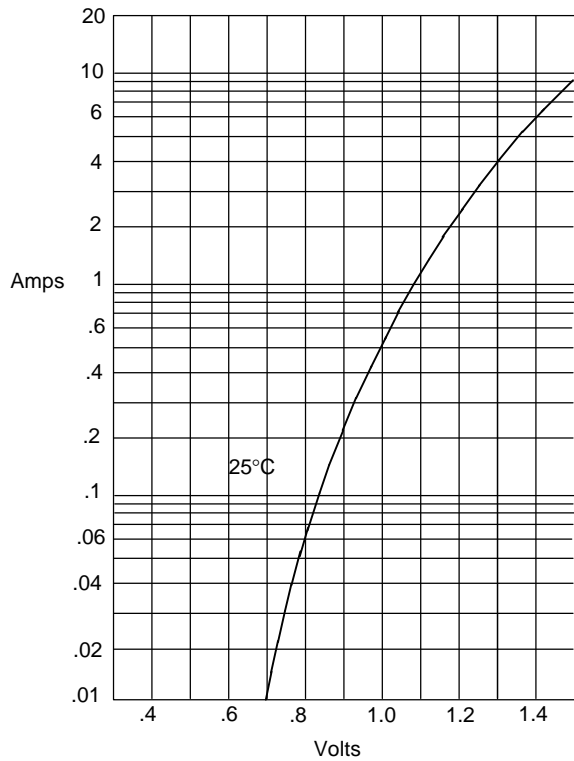
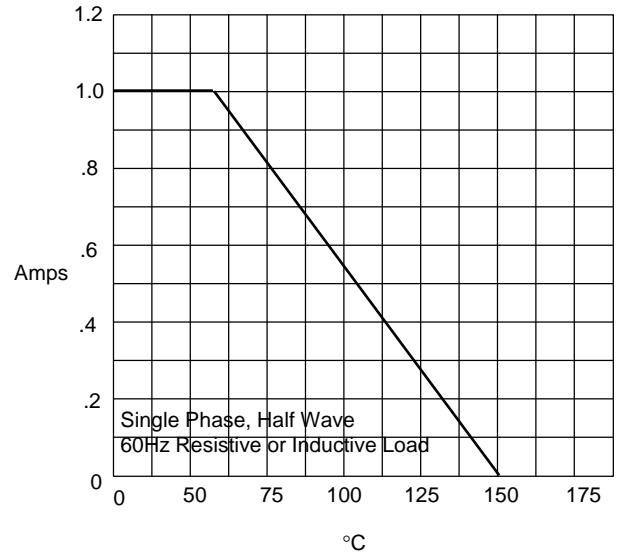

Figure 1  
Typical Forward Characteristics



Instantaneous Forward Current - Amperes *versus*  
Instantaneous Forward Voltage - Volts

Figure 2  
Forward Derating Curve



Average Forward Rectified Current - Amperes/ersus  
Ambient Temperature - °C

Figure 3  
Junction Capacitance

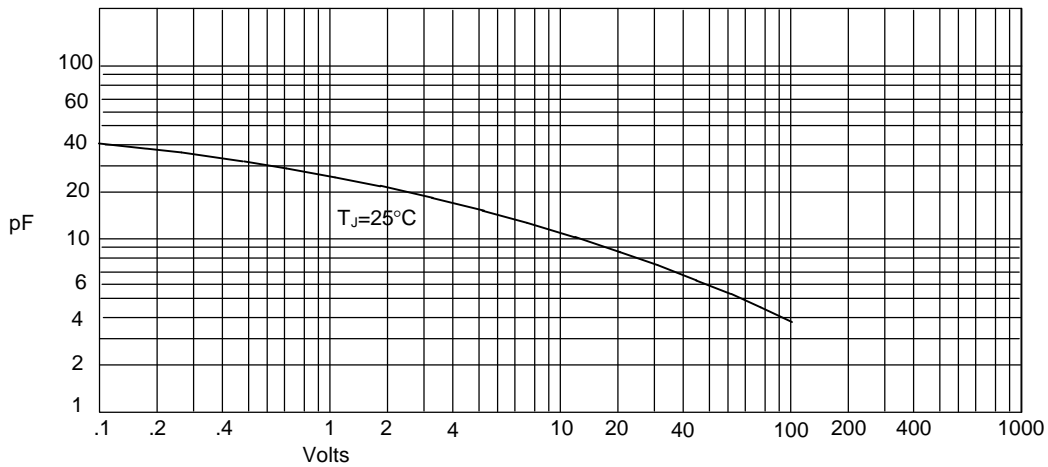

Junction Capacitance - pF *versus*  
Reverse Voltage - Volts

Figure 4  
Typical Reverse Characteristics

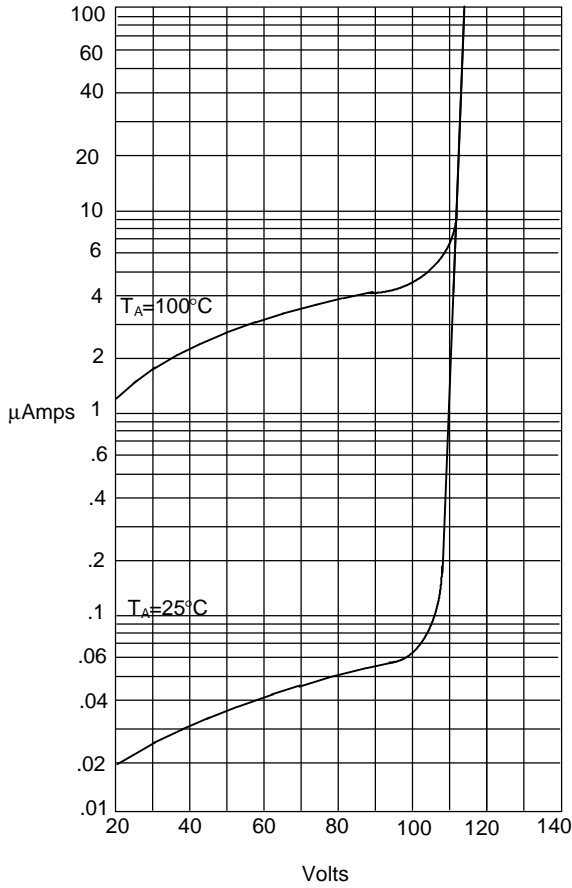

Instantaneous Reverse Leakage Current - MicroAmperes versus  
Percent Of Rated Peak Reverse Voltage - Volts

Figure 5  
Peak Forward Surge Current

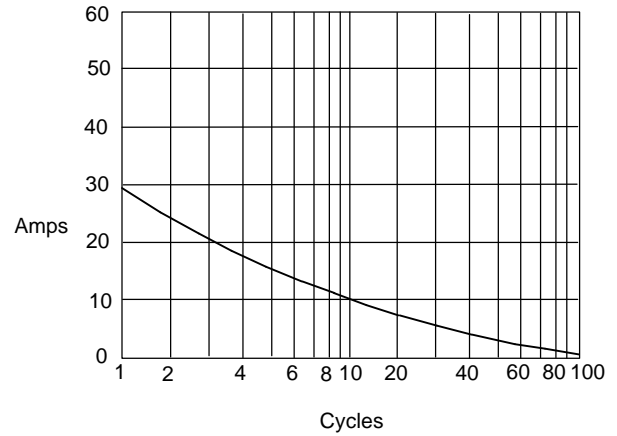

Peak Forward Surge Current - Amperes versus  
Number Of Cycles At 60Hz - Cycles

Figure 6  
Reverse Recovery Time Characteristic And Test Circuit Diagram

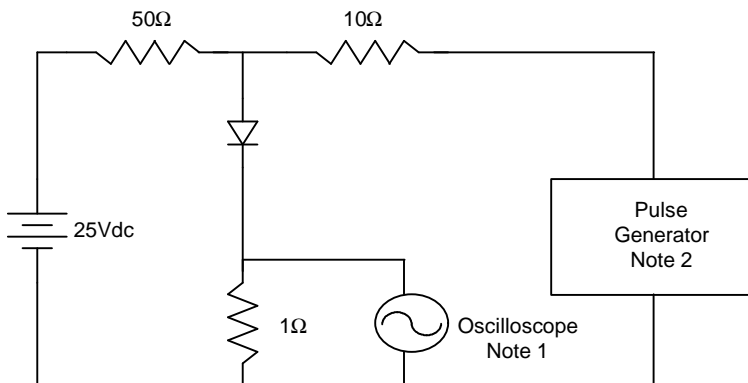

- Notes:
1. Rise Time = 7ns max.  
Input impedance = 1 megohm, 22pF
  2. Rise Time = 10ns max.  
Source impedance = 50 ohms
  3. Resistors are non-inductive

