

Features

1. Normally Open, Single Pole Single Throw
2. Control 350VAC or DC Voltage
3. Switch 130mA Loads
4. LED control Current, 5mA
5. Low ON-Resistance
6. dv/dt, >500V/ms
7. Isolation Test Voltage, 1500VACrms

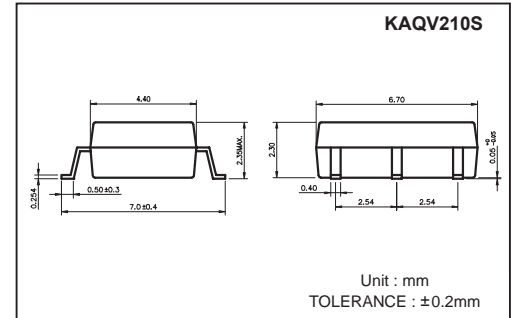

Absolute Maximum Ratings

(Ta=25°C)

Emitter (Input)		Detector (Output)	
Reverse Voltage.....	5.0V	Output Breakdown Voltage	±350V
Continuous Forward Current	50mA	Continuous Load Current	±130mA
Peak Forward Current	1A	Power Dissipation	500mW
Power Dissipation	100mW		
Derate Linearly from 25°C	1.3mW/°C		
General Characteristics			
Isolation Test Voltage	1500VACrms	Storage Temperature Range ...	-40°C to +125°C
Isolation Resistance		Operating Temperature Range...	-30°C to +85°C
Vio=500V, Ta=25°C	≥10 ¹⁰ Ω	Junction Temperature.....	100°C
Total Power Dissipation	550mW	Soldering Temperature,	
Derate Linearly from 25°C	2.5mW/°C	2mm from case, 10 sec	260°C

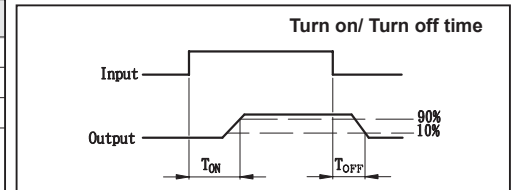

Electro-optical Characteristics

(Ta=25°C)

Parameter	Symbol	Conditions	Min.	Typ.	Max.	Unit
Emitter (Input)						
Forward Voltage	V _F	I _F = 10mA		1.2	1.5	V
Operation Input Current	I _{FON}	V _L = ±20V, I _L = 100mA, t = 10mS			5	mA
Recovery Input Current	I _{FOFF}	V _L = ±20V, I _L ≤ 5uA	0.2			mA
Detector (Output)						
Output Breakdown Voltage	V _B	I _B = 50uA	350			V
Output Off-State Leakage	I _{TOFF}	V _T = 100V, I _F = 0mA		0.2	1	uA
I/O Capacitance	C _{ISO}	I _F = 0, f = 1MHz		6		pF
ON Resistance	Connection	A	I _L = 100mA, I _F = 10mA	20	30	Ω
		B		10	15	
		C		5	7.5	
Turn-On Time	T _{ON}	I _F = 10mA, V _L = ±20V		0.3	1.0	ms
Turn-Off Time	T _{OFF}	t = 10ms, I _L = ±100mA		0.7	1.5	ms

Mos Relay Schematic and Wiring Diagrams

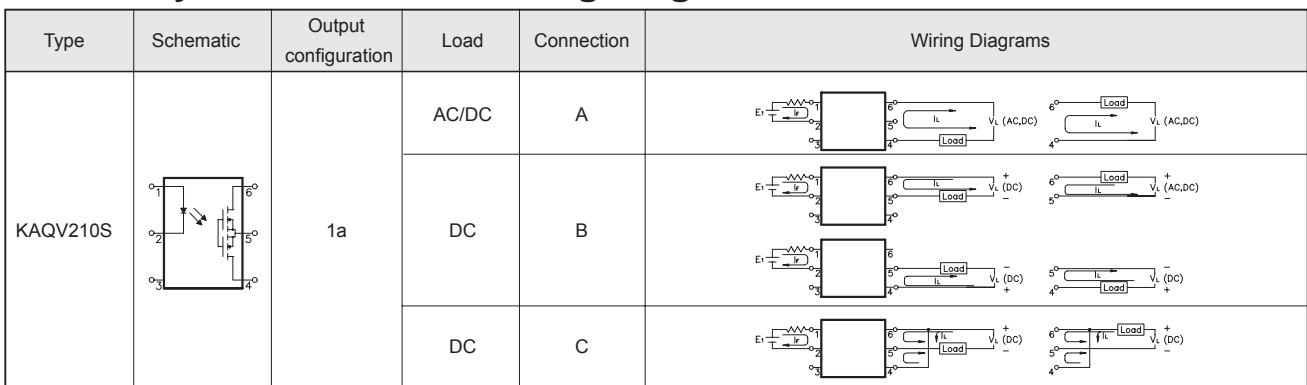

Data Curve

